

McIntosh

MPI-4

MAXIMUM PERFORMANCE
INDICATOR

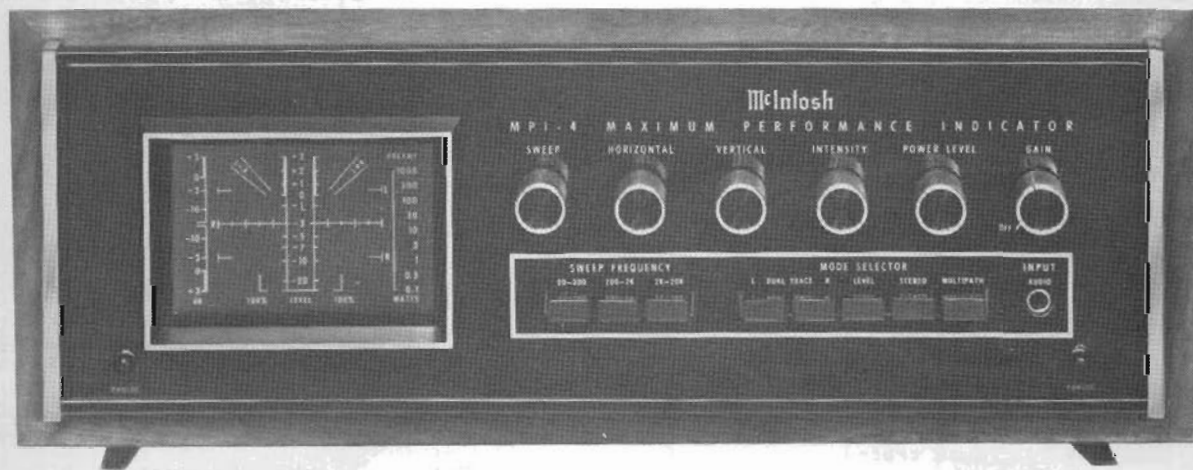

SERVICE INFORMATION

STARTING WITH SERIAL NO. AF1001

McINTOSH LABORATORY INC. 2 CHAMBERS STREET BINGHAMTON, NEW YORK

MPI-4

MULTIPATH MODE OF OPERATION

Sensitivity: 100mV/cm
 Frequency Response: DC to 50kHz (-3dB)
 Input Impedance: 250k Ω
 Signal Strength Polarity: Selectable
 positive or negative

STEREO MODE OF OPERATION

Sensitivity - L (Vertical Amp.): 1.75mV
 rms/cm (5mV P-P/cm)
 - R (Horizontal Amp.): 1.75mV
 rms/cm (5mV P-P/cm)
 Frequency Response: 5Hz to 50kHz (-3dB)
 Input Impedance: 250k Ω

POWER LEVEL MODE OF OPERATION

Sensitivity: 0.1 to 1000 average watts for
 full scale indication (+3dB)
 in 9 calibrated steps.
 Frequency Response: 5Hz to 100kHz (-3dB)
 Input Impedance: 75k Ω
 Calibration: For bridging 4, 8 or 16 ohm
 speaker loads

PREAMP LEVEL MODE OF OPERATION

Sensitivity: 15mV rms for +3dB
 indication
 Frequency Response: 5Hz to 50kHz
 Input Impedance: 250k Ω

SWEEP MODE OF OPERATION

Display modes: Left, right, or both
 (dual trace)
 Sensitivity: 1.6mV rms/cm (4.5mV P-P/cm)
 Frequency Response: 5Hz to 50kHz (-3dB)
 Input Impedance: 250k Ω
 Sweep Frequency: 20Hz to 20kHz in 3
 Decade ranges
 Sweep Expansion: .25X to 5X
 Sweep Trigger: The sweep is triggered only
 in the presence of an input signal.
 In the single trace mode it
 is triggered by the displayed wave-
 form.
 In the dual trace mode the
 trigger is selectable: Left channel,
 right channel, or line frequency.

LEVEL INDICATION MODE

Normal: 250 μ s rise time
 500ms fall time
 Peak: 250 μ s rise time
 100 sec fall time
 Manual reset

LOW PASS FILTER

16kHz L. P. Filter for stereo and sweep modes
 19kHz and 38kHz rejected by at least 30dB

RETICLE LIGHTING

Selectable: On-Off

CRT

3 inch round tube, calibrated 5 x 6cm
 1kV accelerating potential
 Automatic Intensity Control: In the absence
 of a horizontal signal, the intensity
 is reduced to prevent phosphor damage.

SEMICONDUCTOR COMPLEMENT:

2 integrated circuits
 23 Transistors
 10 Light emitting diodes
 29 Diodes

POWER SUPPLIES

All are regulated to give equivalent perform-
 ance for line voltages of 100 to 135 volts.

POWER REQUIREMENTS

120 volts 50/60Hz 50 watts

SIZE

Front panel, 16 inches (40.65cm) wide by
 5-7/16 (13.8cm) high. Chassis, 15 inches
 (38.1cm) wide by 5 inches (12.7cm) high
 by 13 inches (33.1cm) deep. Knob clear-
 ance required, 1-1/2 inches (3.85cm) in
 front of mounting panel.

WEIGHT

21 pounds (9.55kg) Net, 33 pounds (15kg)
 shipping.

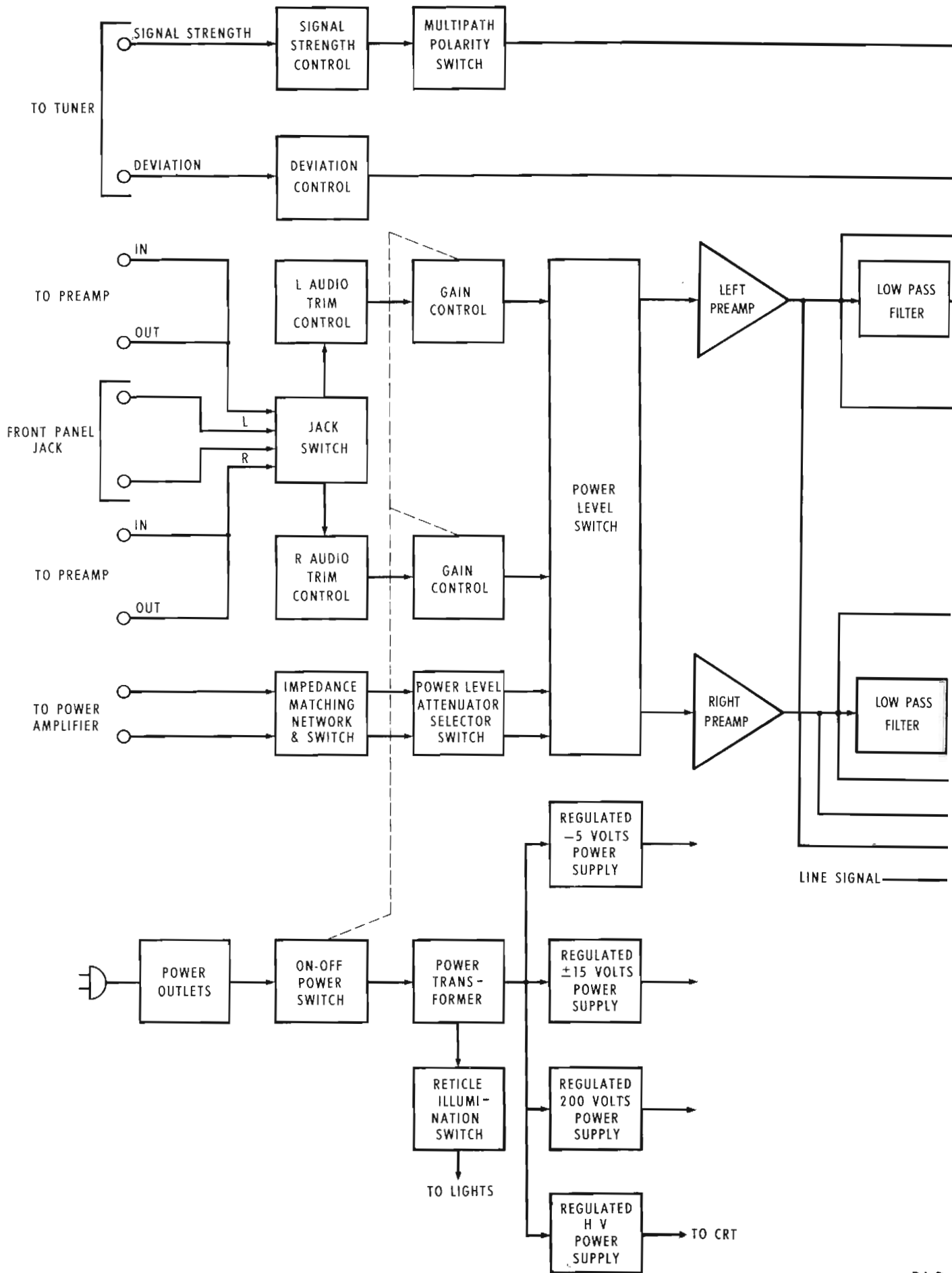

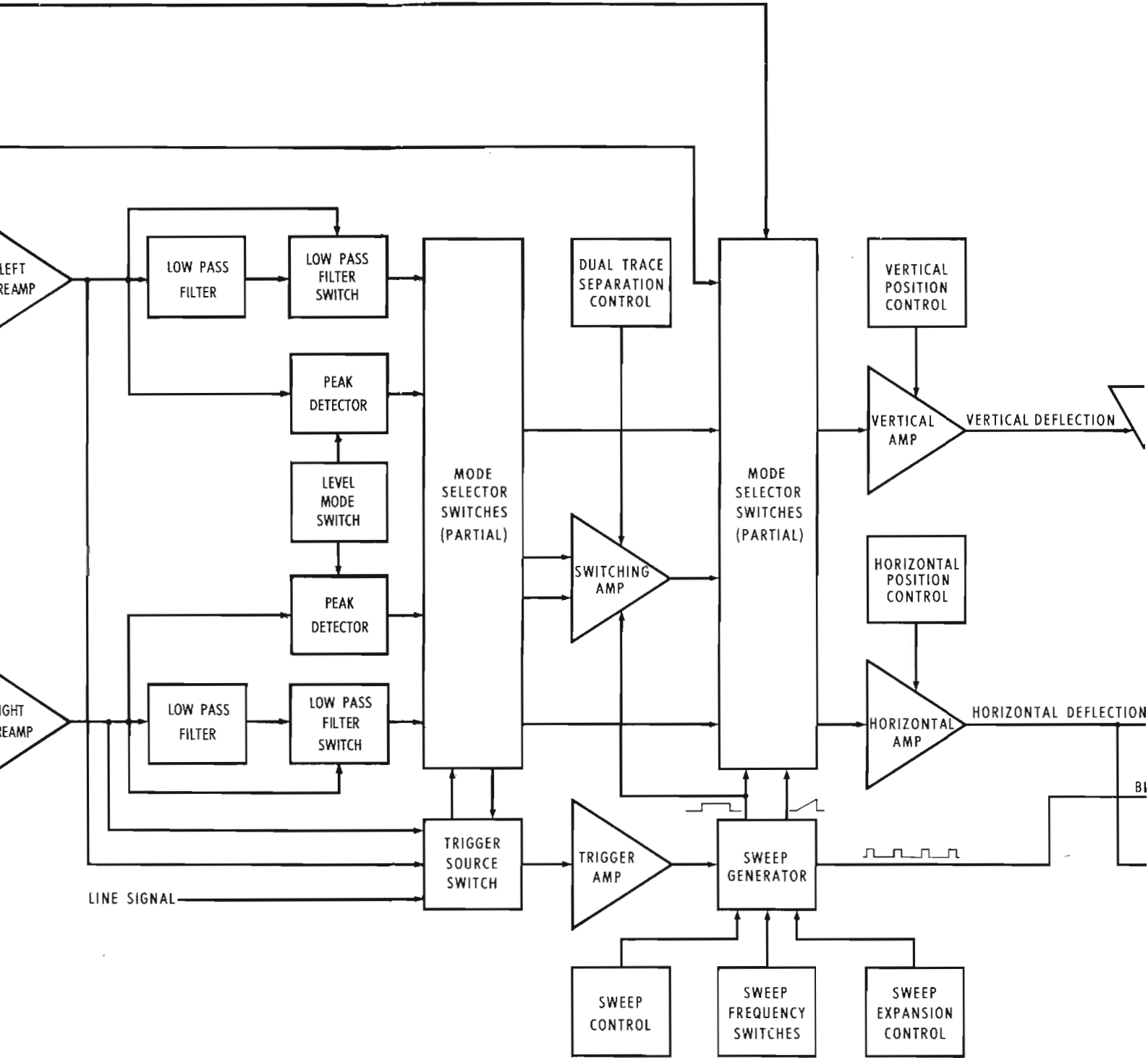

CRT

BLOCK DIAGRAM

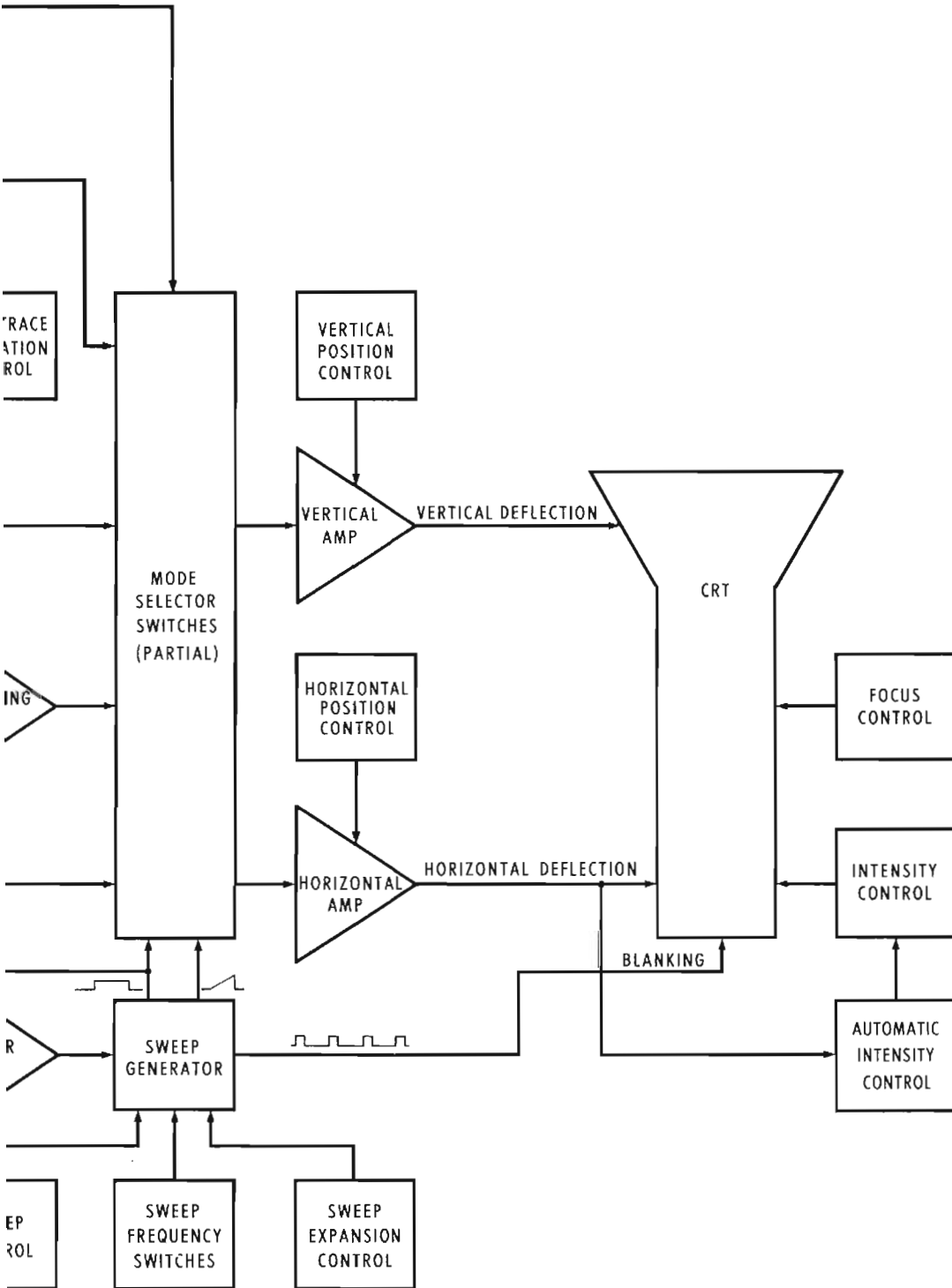

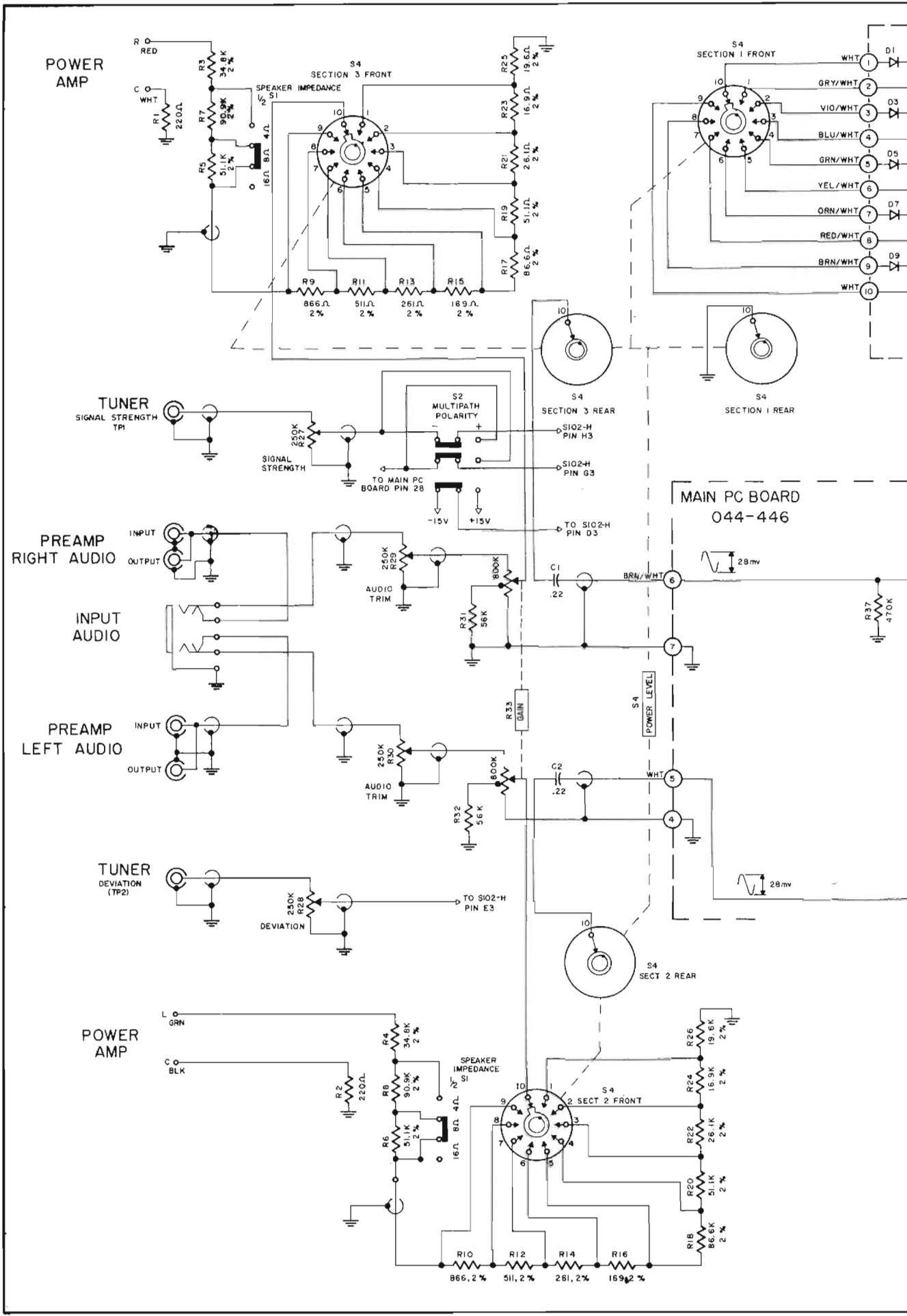

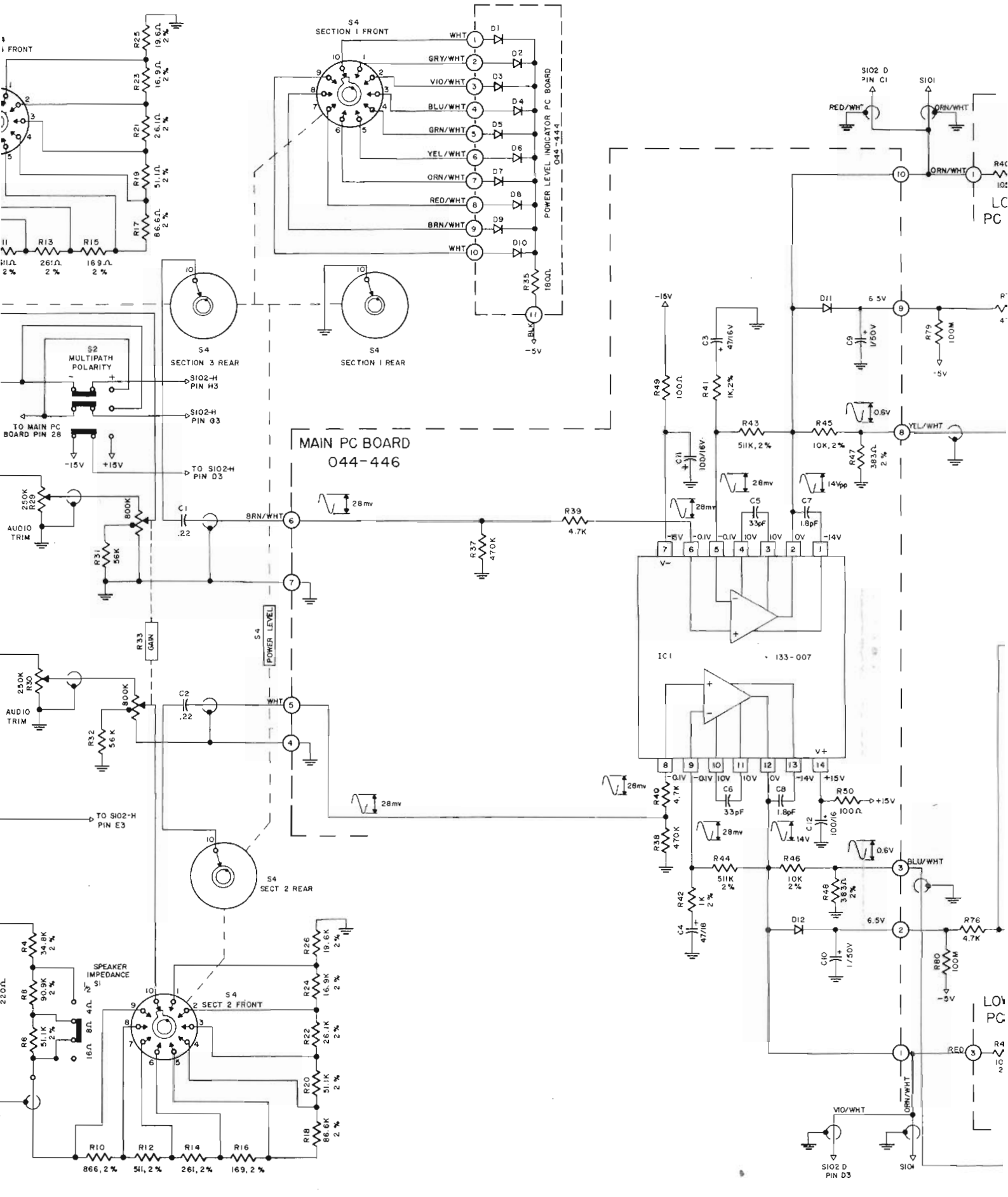

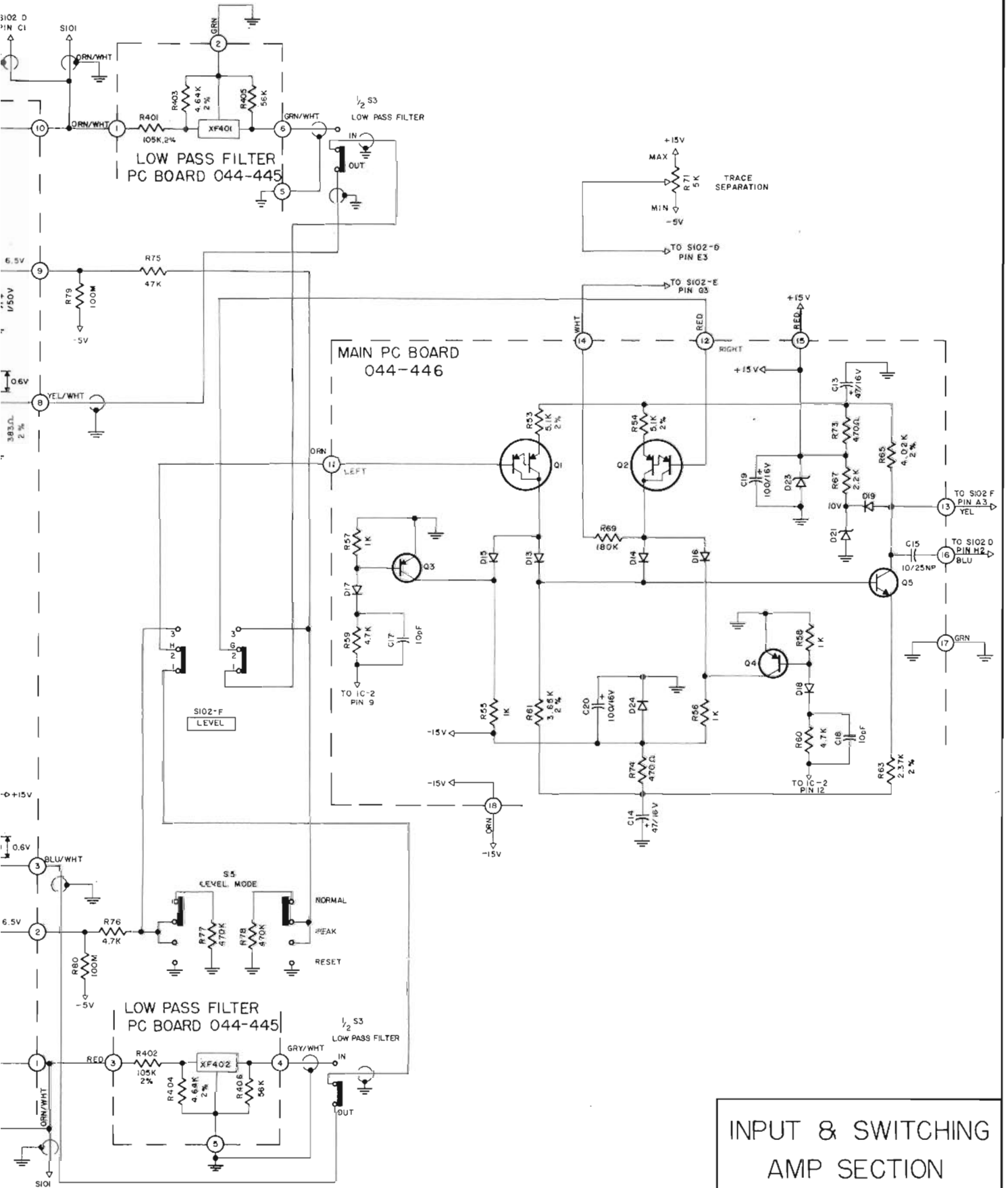

POWER LEVEL PC BOARD 044-444

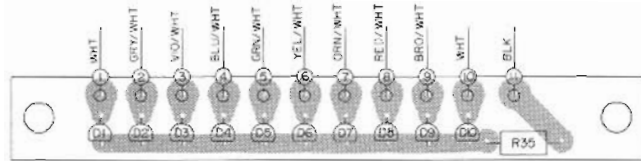

MAIN PC BOARD 044-444

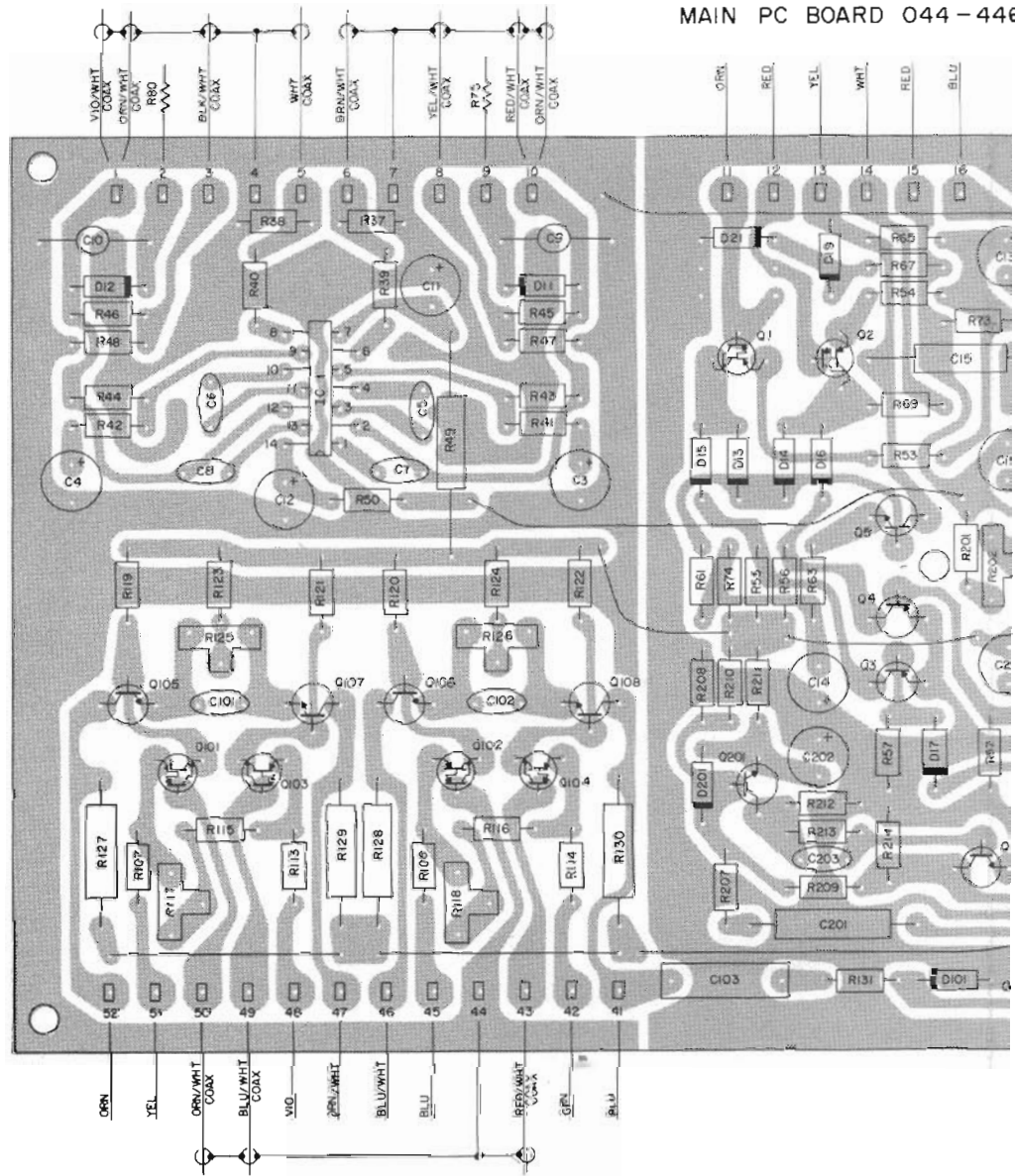

LOW PASS FILTER PC BOARD 044-455

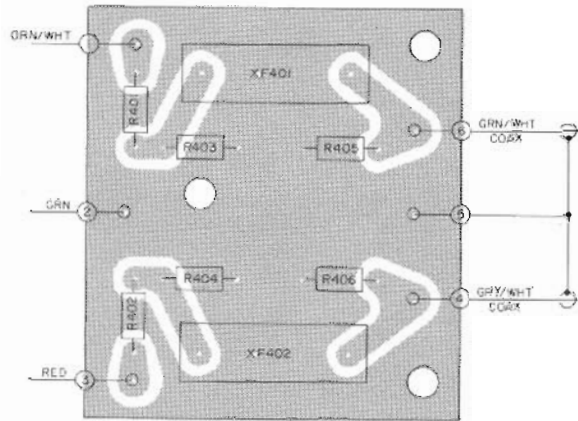

PC BOARD 044-446

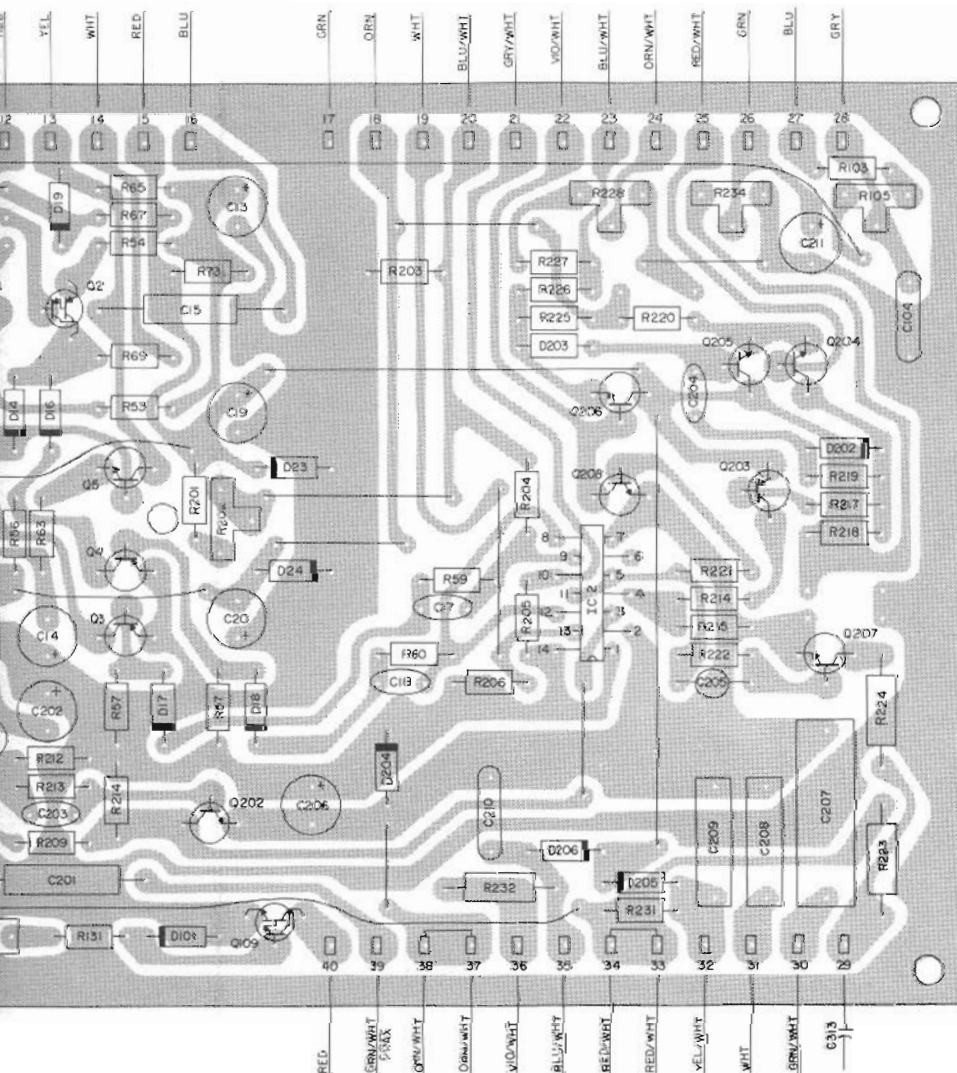

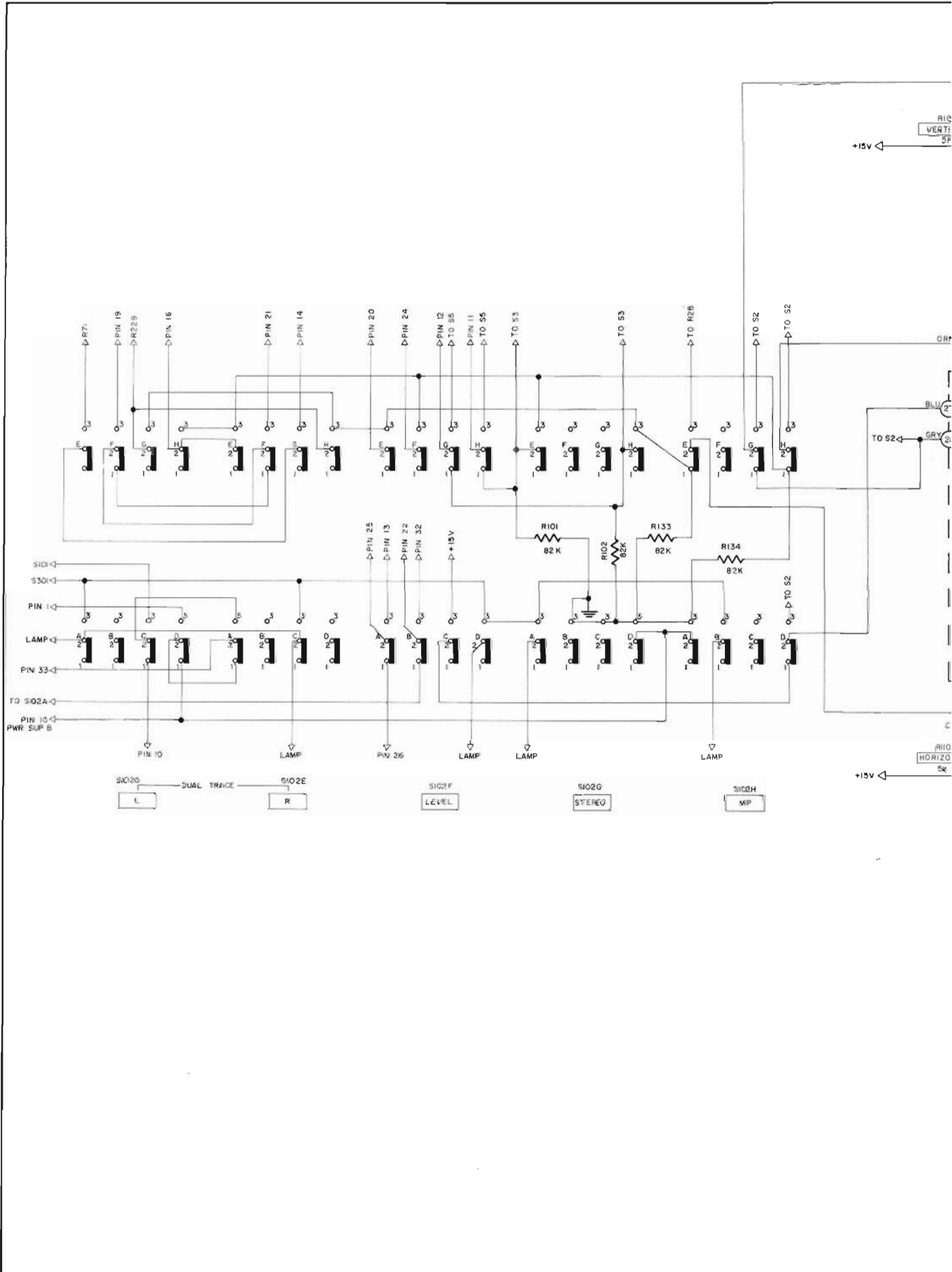

R10
VERTI
5P
+15V

TO S2-4
GRY
2

R10
HORIZO
5K
+15V

SIO2G DUAL TRACE SIO2E
L R
SIO2F
LEVEL
SIO2G
STEREO
SIO2H
MP

MAIN PC BOARD
044-446

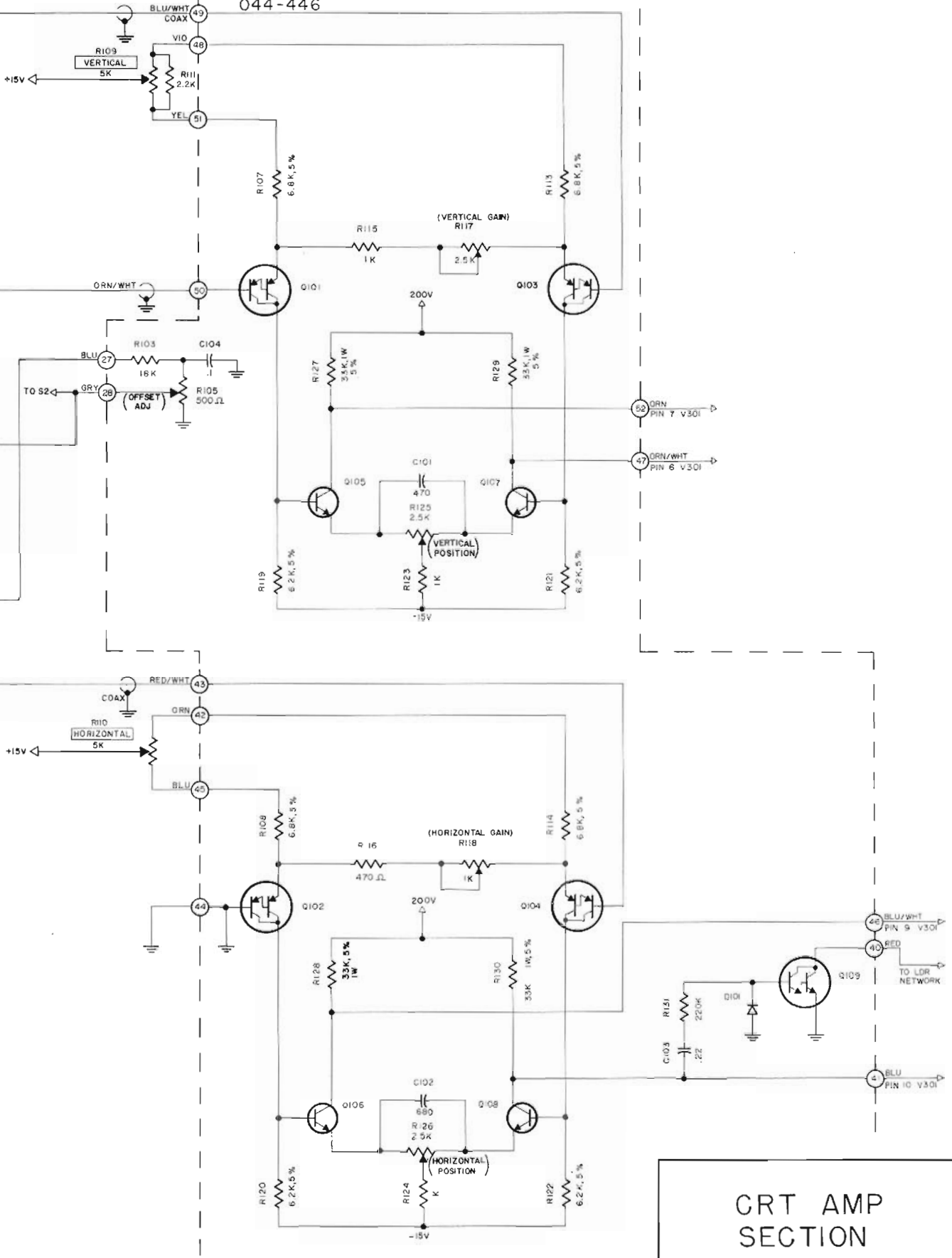

CRT AMP SECTION

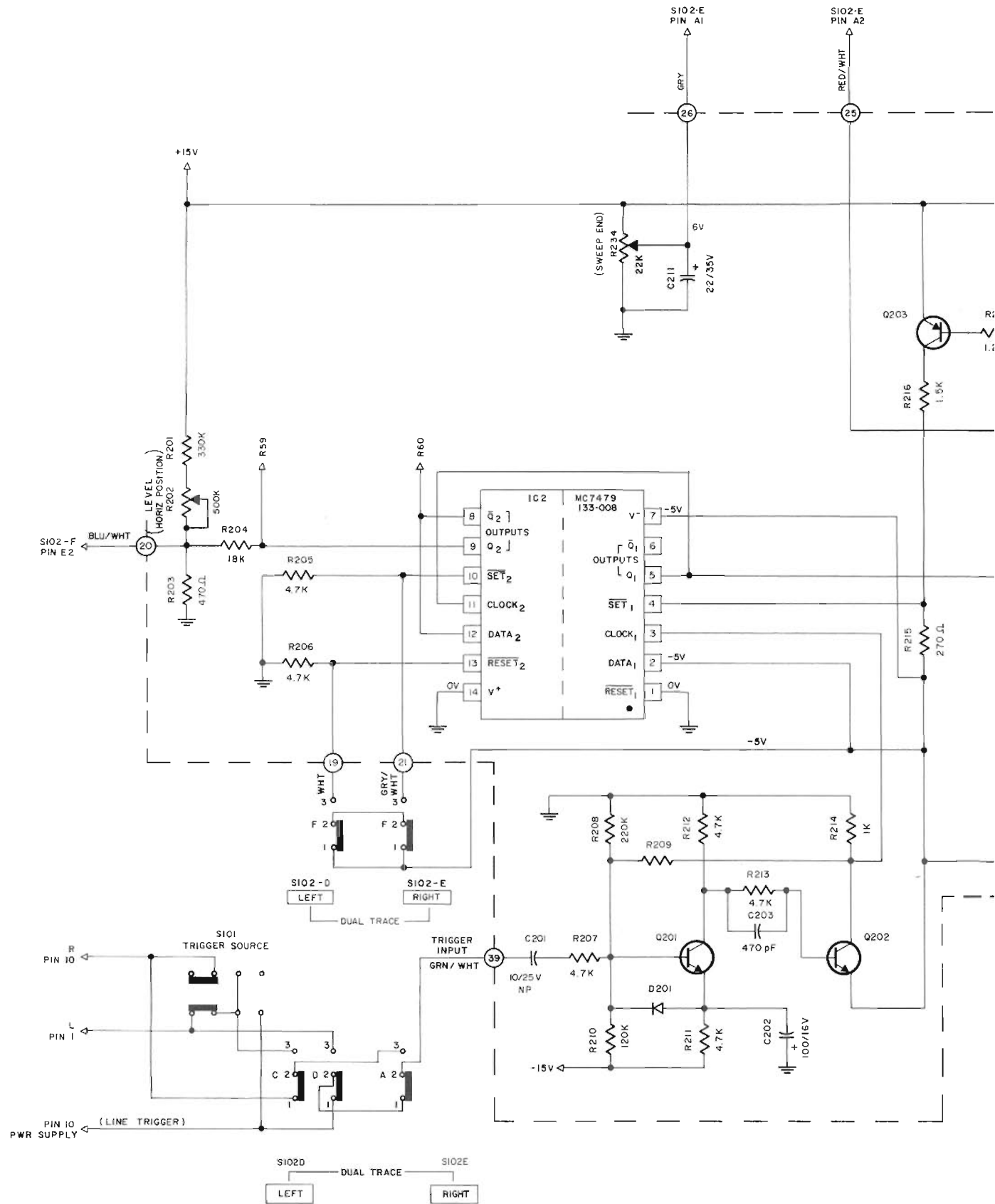

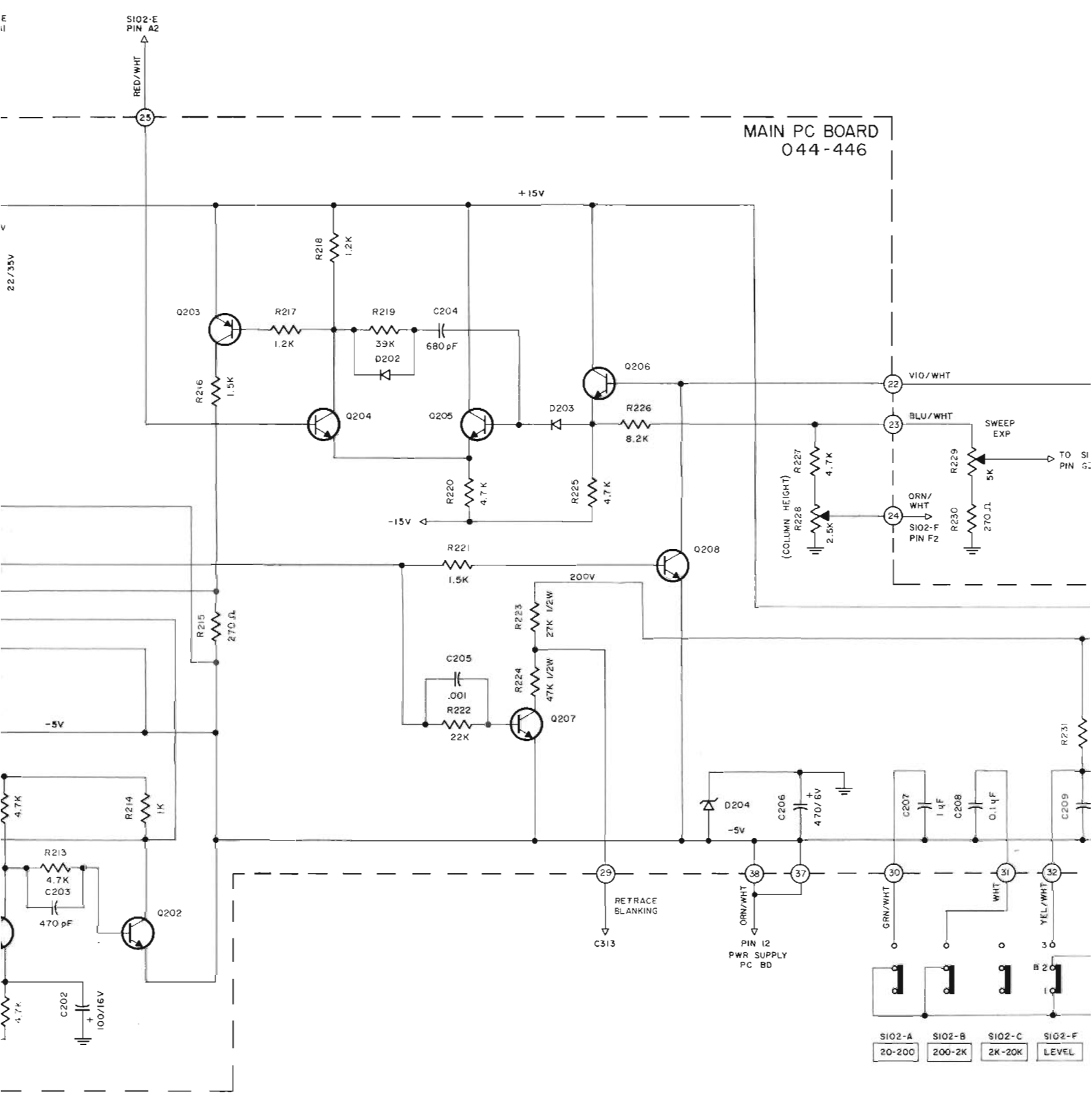

MAIN PC BOARD
044-446

- SIO2-A
20-200
- SIO2-B
200-2K
- SIO2-C
2K-20K
- SIO2-F
LEVEL

MAIN PC BOARD
044-446

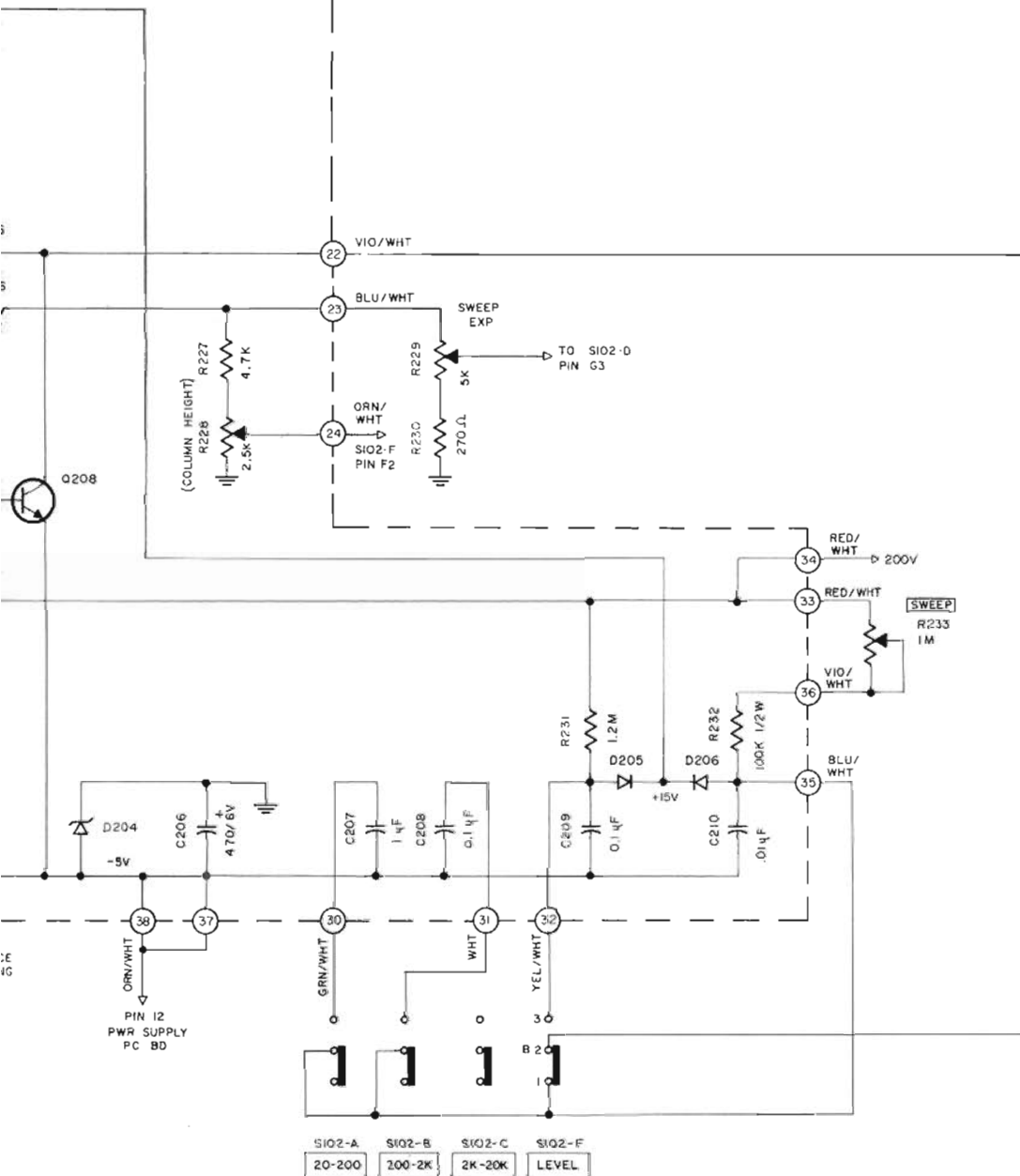

SWEEP SECTION

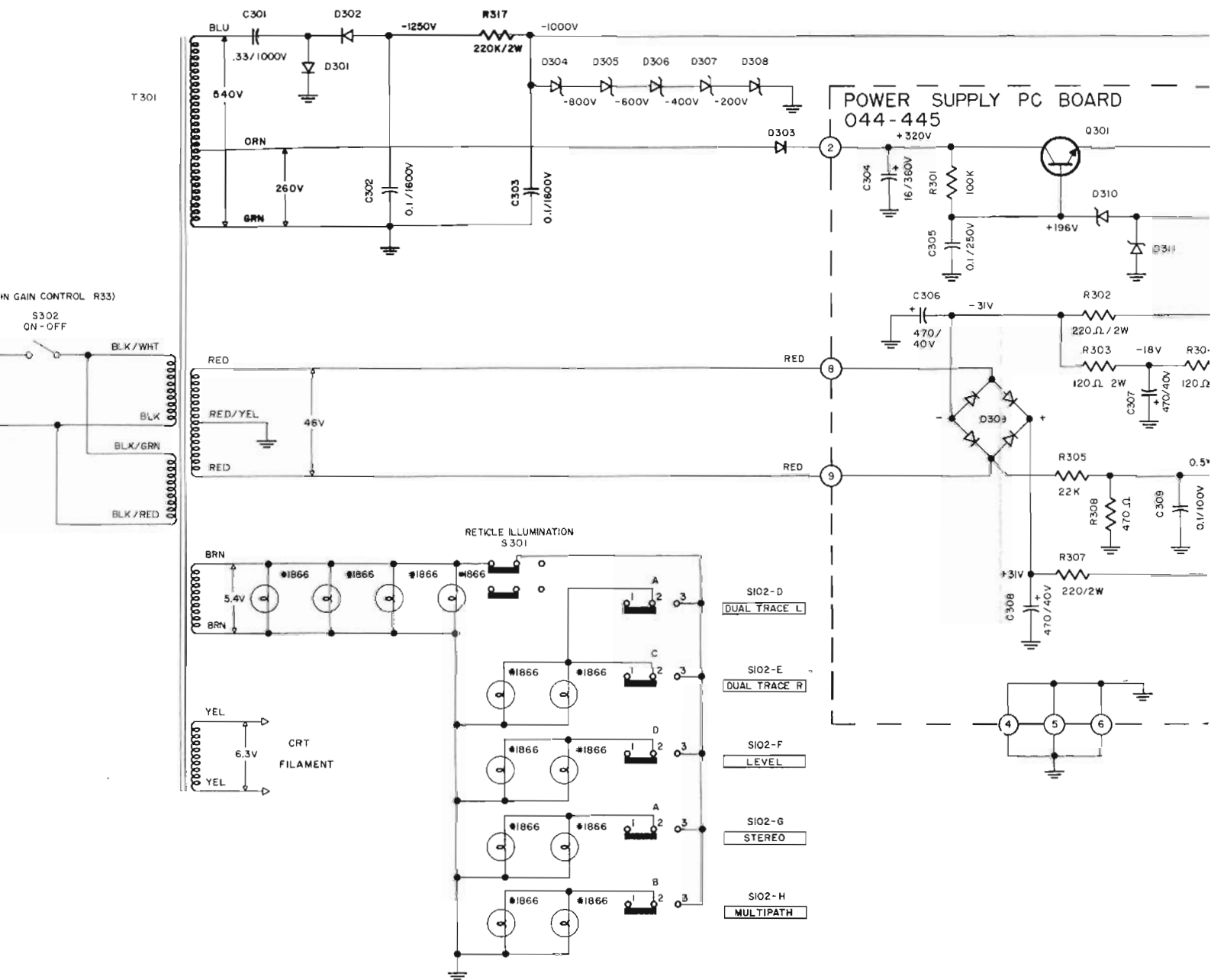

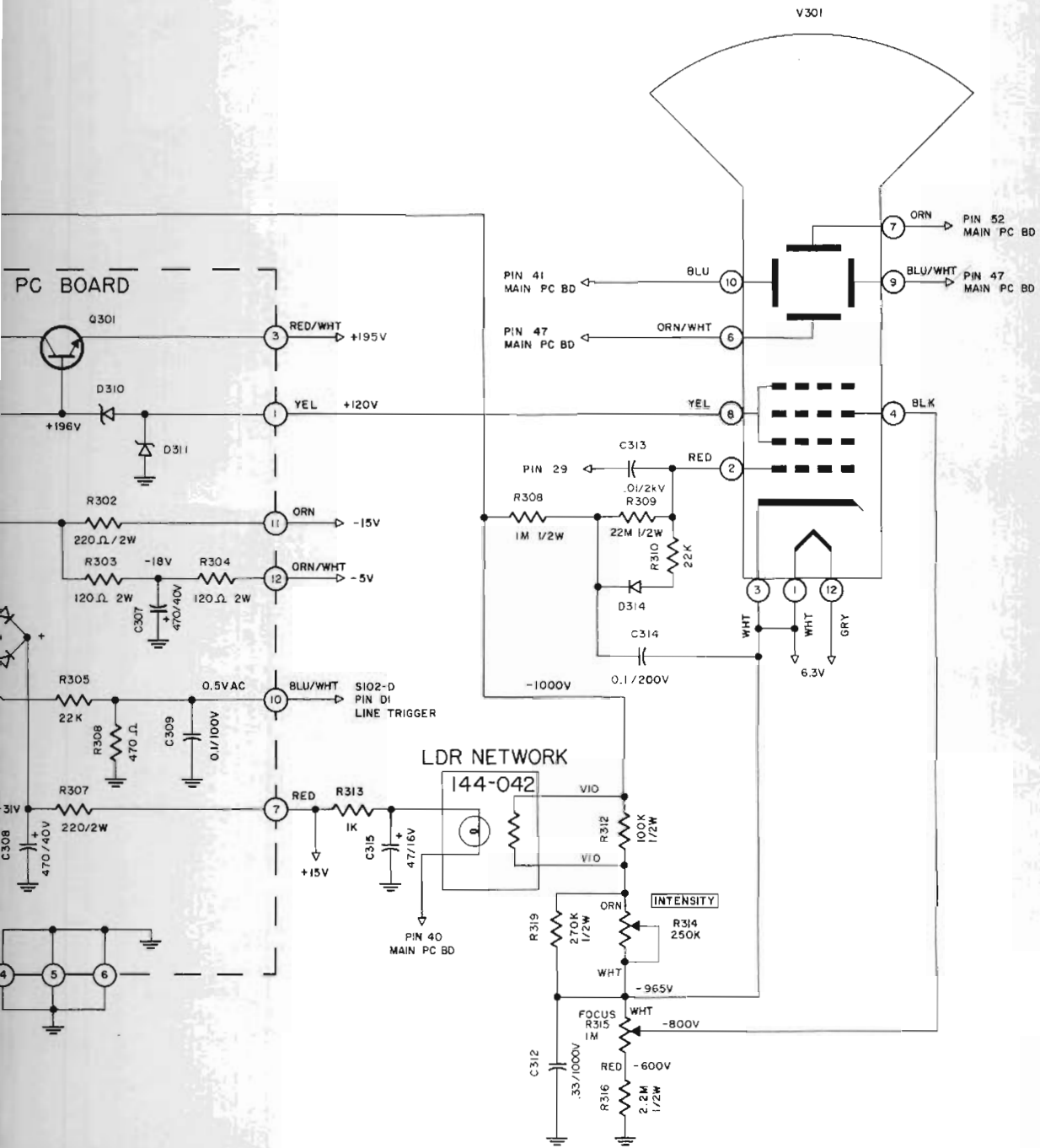

POWER SUPPLY SECTION

POWER SUPPLY PC BOARD 044-445

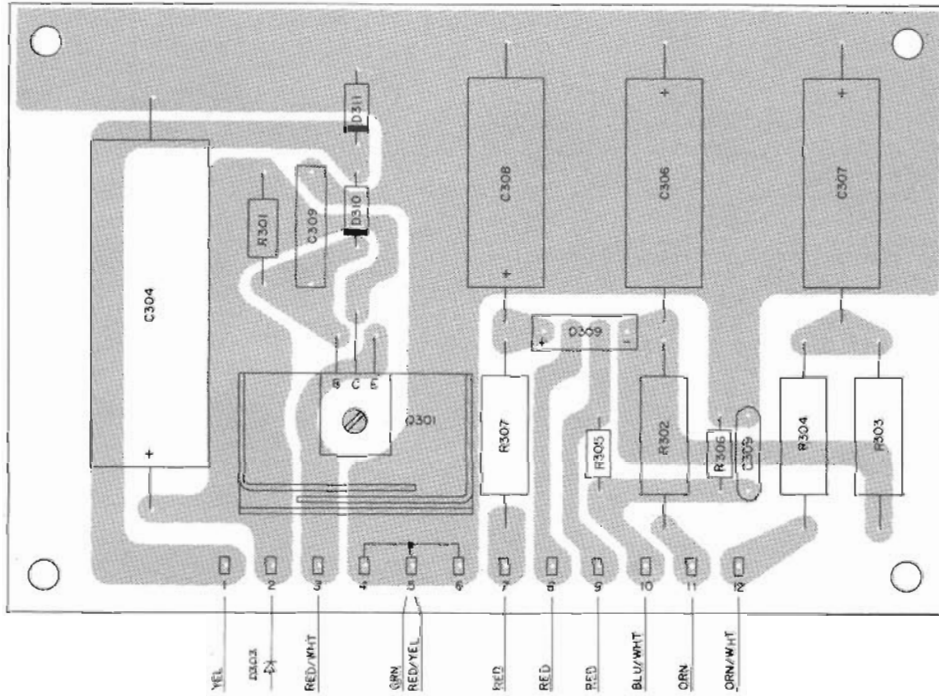

ALIGNMENT INSTRUCTIONS

Vertical Position: STEREO With the front panel vertical control in the middle of its range adjust R125 so that the spot is located in the center of the reticle. (Fig. 1)

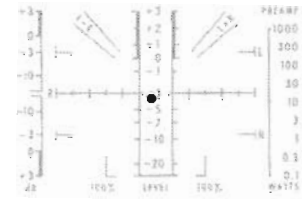

FIG. 1

Horizontal Position: STEREO With the front panel horizontal control in the middle of its range adjust R126 so that the spot is located in the center of the reticle. (Fig. 1)

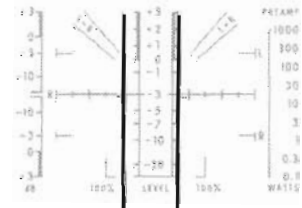

FIG. 2

"Level" Horizontal Position: LEVEL Adjust R202 so that the two level lines are equally spaced about the center. (Fig. 2)

Horizontal Gain: LEVEL Adjust R118 so that the two level lines are located outside the calibration lines and inside the first marks on the Horizontal scale. (R126 may have to be readjusted to bring the spot to the center again) (Fig. 2)

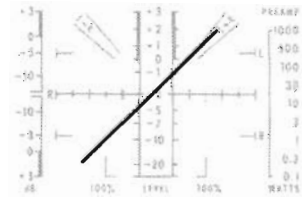

FIG. 3

Vertical Gain: STEREO For a monophonic input adjust R117 so that the diagonal falls between the "L+R" limit lines. If the preamp input is used, it is best to have both the trim controls and the gain control fully clockwise. (R125 may have to be readjusted to bring the spot to the center again) (Fig. 3)

Offset Adjustment: LEVEL With no input and the level mode in its "normal" position adjust R105 so that the tops of the two level lines are even with the bottom of the level scale. (This control also determines the offset for the multipath). (Fig. 4)

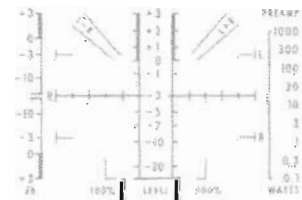

FIG. 4

Column Height: LEVEL With the input over driven adjust R228 so that the tops of the two level lines are even with the +3 mark on the level scale. (R105 may have to be readjusted) (Fig. 5)

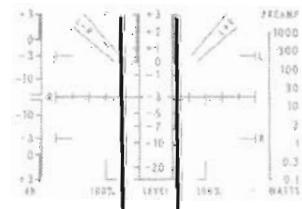

FIG. 5

Sweep End: DUAL TRACE L R With the trigger set to "line" and no input, set the sweep expansion control (level set panel) so that the sweep starts at the left boundary, then adjust R234 so that the sweep stops at the right boundary. (Fig. 6)

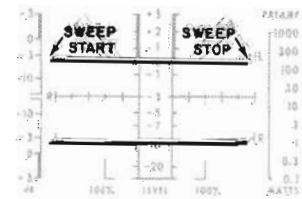













































FIG. 6

MAIN PC BOARD

PINS 1 THRU 10 SEE SCHEMATIC

PIN	DUAL TRACE	L SWEEP	R SWEEP	LEVEL	STEREO	MULTIPATH
11		0V  0.6V		6.5V	0V  0.6V	
12		0V  0.6V		6.5V	0V  0.6V	
13	-0V  0.8V	0V  0.6V		7.5V	0V  0.6V	
14	5V	-12V	4V	-10V	-4V	-12V
15	+15V					
16	-0V  0.8V	0V  0.6V		0 - 10V	0V  0.6V	
17	0V GND					
18	-15V					
19	0V	-5V			0V	
20	0V  0.15V	-0.07V	+0.07V	0V  0.15V		0V
21	0V		-5V		0V	
22		 10V -5V				-5V
23		 2V -2V				-2V
24		 0.4V -0.3V				-0.3V
25		6V		7V		6V
26	6V					
27		0V		15V	0V	+15V / -15V
28		0V		0.26V	0V	+0.26V / -0.26V
29	195V  200V 125V			160V  200V 125V		125V
30	0.5V  +7V -5V			+15V		-5V
31	0V - IF 200-2K BUTTON NOT PRESSED OTHERWISE SIMILAR TO PIN 30					
32		+15V		-1.8V  +8V -5V		+15V
33	+200V					
34	+200V					
35	0.5V  +7V -5V			+15V		-5V
36	200V FOR SWEEP CONTROL CW 20V FOR SWEEP CONTROL CCW					
37	-5V					
38	-5V					
39	0V  15V			0V  1.5V		0V
40		5V  10V				15V
41	120V  90V			120V  22V	120V  90V	120V
42	11V (DEPENDENT ON HORIZONTAL CONTROL [10V - 15V])					
43	0V  0.5V			0V  0.15V	0.0V  0.6V	0V
44	0V GND					
45	11V (DEPENDENT ON HORIZONTAL CONTROL [10V - 15V])					
46	120V  100V			120V  22V	120V  100V	120V
47	110V  80V	110V  60V		140V  50V	110V  50V	130V
48	12V (DEPENDENT ON VERTICAL CONTROL [11V - 15V])					
49	0V			0.2V	0V	0V (-MP POLARITY) 0.2V (+MP POLARITY)
50	0V  0.7V	0V  0.6V		-0.1V  0.5V	0V  0.5V	-0.2V (-MP POLARITY) 0V (+MP POLARITY)
51	12V (DEPENDENT ON VERTICAL CONTROL [12V - 15V])					
52	110V  70V	110V  60V		80V  50V	110V  50V	90V

TSTR	DUAL TRACE	L SWEEP	R SWEEP	LEVEL	STEREO	MULTIPATH		
Q1	C		-4.3V	-12V		-4.3V OR -12.3V		
	B	0V		6.5V	0V			
	E	1.1V		0.6V	7.3V	1.1V		
Q2	C		-12.3V	-4.3V		-4.3V OR -12.3V		
	B	0V		0.6V	6.5V	0V		
	E	1.1V		0.6V	7.3V	1.1V		
Q3	C	-6.5V	-0.2V	-13V	-7V	0V OR -13V		
	B	-0.4V	-0.7V	0V	-0.4V	0V OR -0.7V		
	E	0V GND						
Q4	C	-6.5V	-13V	-0.2V	-7V	0V OR -13V		
	B	0.4V	0V	-0.7V	-0.4V	0V OR -0.7V		
	E	0V GND						
Q5	C	-0V	0V		7.5V	0V		
	B	-5V	-5V		-9.5V	-5V		
	E	-5.7V	-5.7V		-10.2V	-5.7V		
Q101	C	-5V	-5V		-4V	-5V		-4.5V
	B	0V	0V		-0.1V	0V		-0.2V (-MP POLARITY) 0V (+MP POLARITY)
	E	1.1V	1.1V		1V	1.1V		1.1V
Q102	C	-5.3V	4V	-5.3V	-5.3V		-5.3V	
	B	0V GND						
	E	1.1V		0.03V	1.1V	1.1V		1.1V
Q103	C	-5.3V	-5.3V		-6.5V	-5.3V		-6V
	B	0V	0V	0V	0.2V	0V		0V (-MP POLARITY) 0.2V (+MP POLARITY)
	E	1.1V	1.1V		0.02V	1.1V		1.1V
Q104	C	-5.3V	4V	-5.3V	-5.3V		-5.3V	
	B	0V		0.5V	0V	0.0V		0V
	E	1.1V		0.5V	1.1V	1.1V		1.1V
Q105	C	110V	110V		80V	110V		90V
	B	-5V	-5V		-4V	-5V		-4.5V
	E	-5.7V	-5.7V		-4.5V	-5.7V		-5V
Q106	C	120V		100V	120V	120V		120V
	B	-5.3V		4V	-5.3V	-5.3V		-5.3V
	E	-5.8V		3.5V	-5.8V	-5.8V		-5.8V
Q107	C	110V	110V		140V	110V		130V
	B	-5.3V	-5.3V		-6.5V	-5.3V		-6V
	E	-5.8V	-5.8V		-7V	-5.8V		-6.5V
Q108	C	120V		90V	120V	120V		120V
	B	-5.3V		4V	-5.3V	-5.3V		-5.3V
	E	-5.8V		4V	-5.8V	-5.8V		-5.8V
Q109	C	5V		10V	15V			
	B	0.4V		+1.5V -0.5V	0.4V	0.4V		0V
	E	0V GND						

TSTR	DUAL TRACE	L SWEEP	R SWEEP	LEVEL	STEREO	MULTIPATH
Q201	C				-7.5V	
	B				-7V	
	E				-7.6V	
Q202	C				0V	
	B				-7.5V	
	E	-5V				
Q203	C				+15V	
	B				14.5V	
	E	+15V				
Q204	C				12V	
	B	5.5V		7.2V	5.5V	
	E				5V	
Q205	C	+15V				
	B				0V	
	E				5V	
Q206	C	+15V				
	B				-5V	
	E				-5.5V	
Q207	C				-5V	
	B				-4.4V	
	E	-5V				
Q208	C				-5V	
	B				-4.3V	
	E	-5V				

IC-2	DUAL TRACE	L SWEEP	R SWEEP	LEVEL	STEREO	MULTIPATH
1				0V		
2				-5V		
3					0V	
4					-2V	
5					-2V	
6					-5V	
7		-5V				
8		0V	-5V		-5V OR 0V	
9		-5V	0V		-5V OR 0V	
10	0V		-5V	0V		
11					-2V	
12		0V	-5V		-5V OR 0V	
13	0V	-5V	0V			
14				0V		

SCHMATIC NOTES

1. Unless otherwise specified: Resistance values are in ohms, 1/4 watt, and 10% tolerance; Capacitance values smaller than 1 are in microfarads (μF); capacitance values greater than 1 are in picofarads (pF); inductors are in microhenries (μH).
2. Printed circuit board components are outlined on the schematics by dotted lines. The circled numbers around the dotted lines correspond to the numbers on the PC Board layouts.
3. The terminal numbering of rotary switches is for reference only.
4. All voltages indicated are measured under the following conditions:
 - a. Use of an 11 megohm input impedance VTVM.
 - b. Tuner Input: None
 - c. Preamp Input: 10 MV rms, 1kHz (Left & Right)
 - d. Power Amp Input: None
 - e. Controls At:

Sweep:	Fully clockwise	Filter:	Out
Vertical:	Center	Trigger Source:	Left
Horizontal:	Center	Trace Separation:	Normal
Intensity:	Normal	Sweep Expansion:	Normal (X1)
Power Level:	Preamp	Trim:	Fully clockwise
Gain:	Fully clockwise	Sweep Frequency:	20 - 200
Level Mode:	Normal		
 - Mode Selector: Refer to "Voltage and Waveform" chart for voltages at PC Board, transistor and IC pins. Voltages change with the positions of the mode selector pushbutton switch. Voltages that are not affected by the mode selector are on the schematic diagram.

 All voltages are D.C. except those shown with an A.C. signal. If a pin has both a D.C. voltage and an A.C. signal the D.C. voltage is written first.
5. The voltages shown are typical and will not necessarily be the same for every unit. Variations of $\pm 25\%$ are not unusual.

All
able

Repl
by P

Symb
Numb

C1,2

C3,4

C9,1

C11,

C13,

C15

C103

C201

C202

C206

C207

C208

C210

C211

C301

C302

C304

C305

C306

C308

C310

C312

C314

C315

D1,2

D3,4

D5,6

D7,8

D9,1

D11,

D13,

REPLACEMENT PARTS

All parts not listed are common items obtainable from radio parts jobbers.

Replacement parts may be obtained when ordered by PART NUMBER from:

McIntosh Laboratory, Inc.
Customer Service Department
2 Chambers Street
Binghamton, New York 13903
(telephone 607-723-3512)

CAPACITORS

Symbol Number	Description	Part Number
C1,2	Mylar .22 μ F 200V	064-043
C3,4	Elect 47 μ F 16V	066-182
C9,10	Tant Elect 1 μ F 50V	066-175
C11,12	Elect 100 μ F 16V	066-177
C13,14	Elect 47 μ F 16V	066-182
C15	Elect 10 μ F 25V	066-005
C103	Mylar .22 μ F 250V	064-068
C201	Elect 10 μ F 25V	066-005
C202	Elect 100 μ F 16V	066-177
C206	Elect 470 μ F 6V	066-197
C207	Mylar 1 μ F 250V	064-088
C208,209	Mylar .1 μ F 250V	064-067
C210	Mylar .01 μ F 250V	064-101
C211	Elect 22 μ F 35V	066-179
C301	Paper .33 μ F 1000V	064-109
C302,303	Paper .1 μ F 1600V	064-110
C304	Elect 16 μ F 350V	066-196
C305	Mylar .1 μ F 250V	064-067
C306,307	Elect 470 μ F 40V	066-134
C308	Elect 470 μ F 40V	066-134
C310,311	Elect 100 μ F 16V	066-177
C312	Paper .33 μ F 1000V	064-109
C314	Mylar .1 μ F 200V	064-067
C315	Elect 47 μ F 16V	066-182

DIODES

D1,2	Light emitting diode	070-056
D3,4	Light emitting diode	070-056
D5,6	Light emitting diode	070-056
D7,8	Light emitting diode	070-056
D9,10	Light emitting diode	070-056
D11,12	Si. signal diode	070-047
D13,14	Si. signal diode	070-047

D15,16	Si. signal diode	070-047
D17,18	Si. signal diode	070-047
D19	Si. signal diode	070-047
D21	Zener diode 10V	070-024
D101	Si. signal diode	070-047
D201,202	Si. signal diode	070-047
D203	Si. signal diode	070-047
D204	Zener diode 4.7V	070-057
D205,206	Si. signal diode	070-047
D301,302	Diode 2000V	070-058
D303	Diode 800V	070-059
D302,305	Zener diode 200V	070-060
D306,307	Zener diode 200V	070-060
D308	Zener diode 200V	070-060
D309	Bridge Rectifier	070-044
D310	Zener diode 75V	070-025
D311	Zener diode 120V	070-062
D312,313	Zener diode 15V	070-061
D314	Si. signal diode	070-047

TRANSISTORS

Q1,2	Si. PNP transistor	132-100
Q3,4	Si. PNP transistor	132-096
Q5	Si. NPN transistor	132-092
Q101,102	Si. PNP transistor	132-100
Q103,104	Si. PNP transistor	132-100
Q105,106	Si. NPN transistor	132-102
Q107,108	Si. NPN transistor	132-102
Q109	Si. NPN transistor	132-090
Q201,202	Si. NPN transistor	132-092
Q203	Si. PNP transistor	132-096
Q204,205	Si. NPN transistor	132-092
Q206	Si. NPN transistor	132-092
Q207	Si. NPN transistor	132-102
Q208	Si. NPN transistor	132-042
Q301	Si. NPN transistor	132-102

FUSES

F301	Fuse 1/2A	089-009
------	-----------	---------

POTENTIOMETERS

R27	Signal strength control	134-252
R28	Deviation control	134-252
R29	Audio trim control	134-252
R30	Audio trim control	134-252
R33	Gain control	134-251

MPI-4

R71	Trace separation control	134-219
R109	Vertical control	134-244
R110	Horizontal control	134-244
R233	Sweep control	134-250
R229	Sweep expansion control	134-219
R314	Intensity control	134-248
R315	Focus control	134-249

SWITCHES

S1	Speaker impedance	148-033
S2	Multipath polarity	148-032
S3	Lo Pass filter	148-031
S4	Power level switch	146-161
S5	Level mode	148-034
S101	Trigger source	148-033
S102	Mode selector	150-011
S301	Reticle illumination	148-031

TRANSFORMERS

T301	Power transformer	159-091
------	-------------------	---------

TUBES

V301	Cathode ray tube	165-062
------	------------------	---------

INTEGRATED CIRCUITS

IC1	Integrated circuit	133-007
IC2	Integrated circuit	133-008

LAMPS

#1866	Front panel	058-014
#1866	Reticle illumination	058-014

FRONT PANEL & TRIM

	Front panel	044-439
	Front panel end caps	018-160
	Sweep knob	044-429
	Horizontal knob	044-429
	Vertical knob	044-429
	Intensity knob	044-429
	Power level knob	044-429
	Gain knob	044-430
	Focus knob	090-122
	trace separation knob	090-121
	Sweep expansion knob	090-121
	Signal strength knob	090-121
	Audio trim knob	090-121
	Pushbutton	017-128

MISCELLANEOUS ITEMS

Plastic feet	017-156
Shipping carton	044-538
Push terminal strip	074-030
Owners manual	038-439
AC line cord	170-021
Fuse holder	170-033
Audio cable	176-135

MOUNTING SYSTEM

Shelf bracket (right)	043-622
Shelf bracket (left)	043-623
Mounting template #100	038-179
Hardware package	044-440

MODULES

LDR Network	144-042
-------------	---------

15C0406S7-M3438-1